

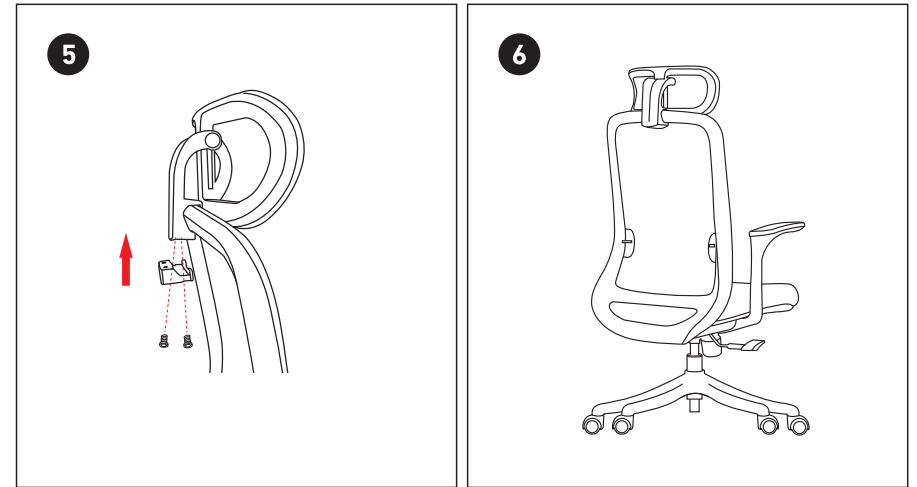

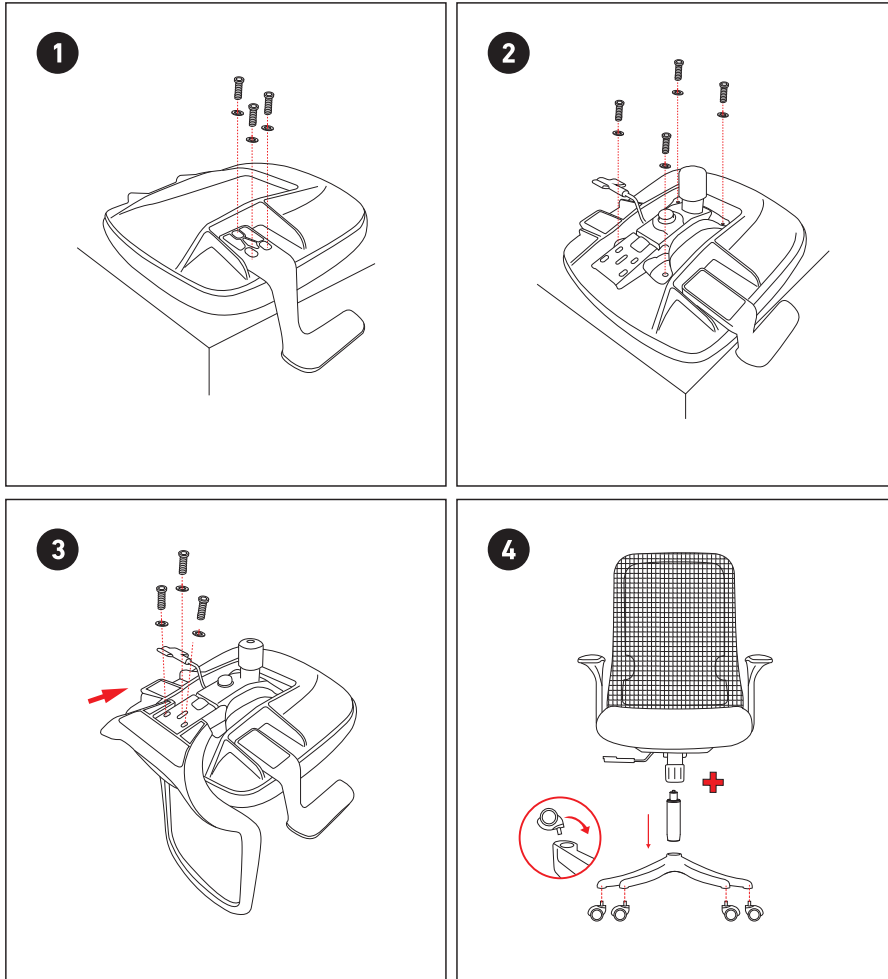



# ASSEMBLY INSTRUCTION

# HYPERWORK CLOUD CHAIR

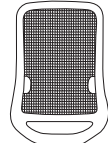
HPW - OC03

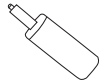

## PARTS LIST

			
BACK x 1	SEAT x 1	HEAD PILLOW x 1	ARM x 2
			
MECHANISM x 1	WHEEL x 5	BASE x 1	GAS LIFT x 1

## HARDWARE LIST

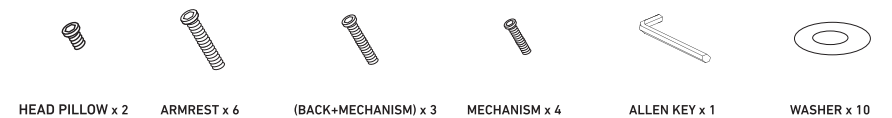

# HƯỚNG DẪN LẮP ĐẶT

# HYPERWORK CLOUD CHAIR

HPW - OC03

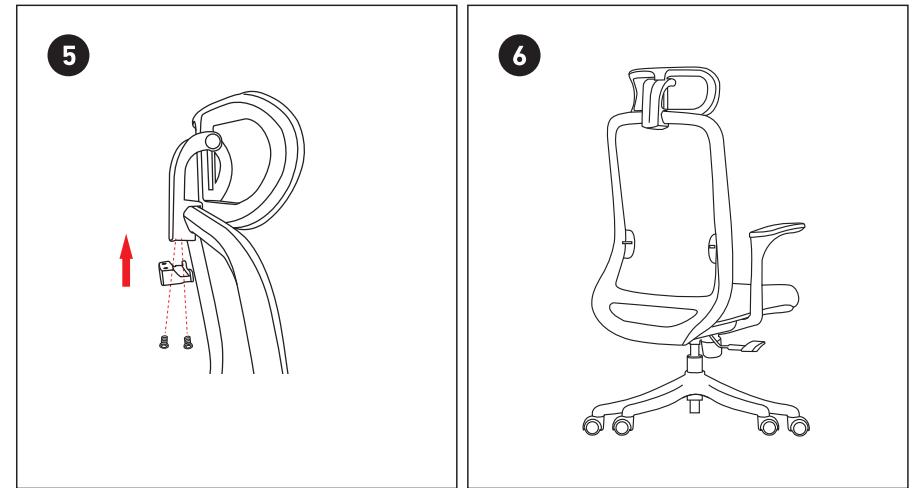
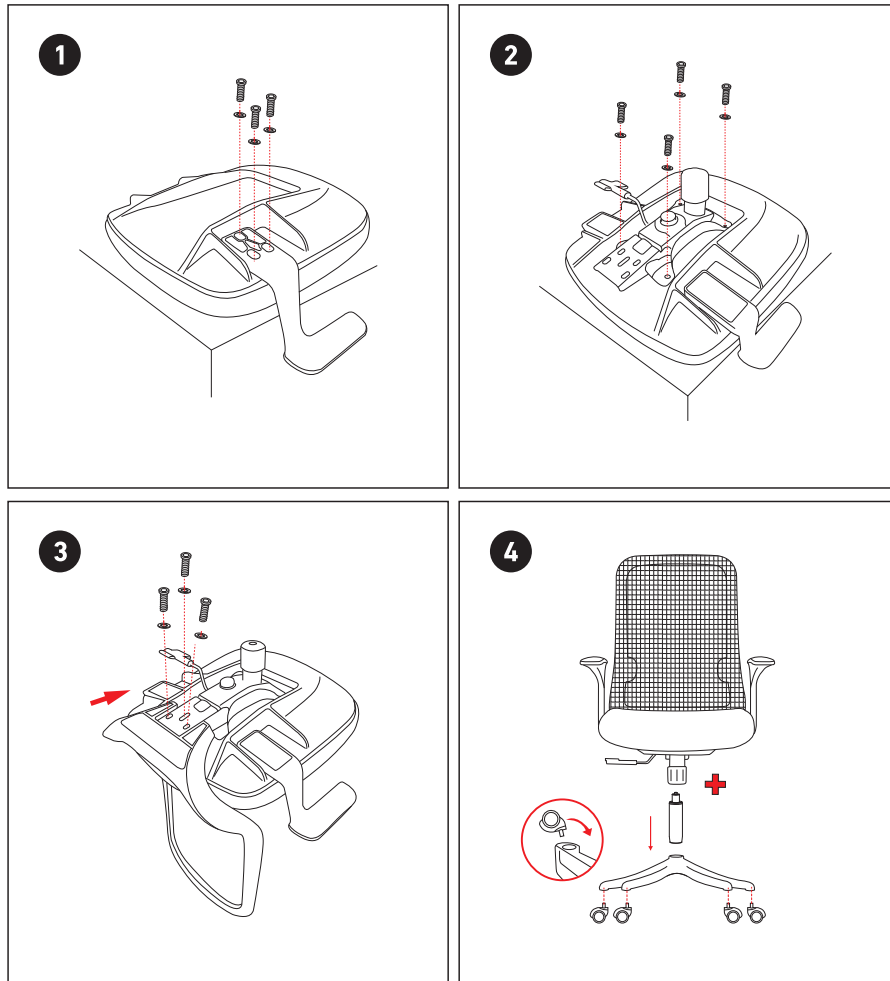

## DANH SÁCH LINH KIỆN

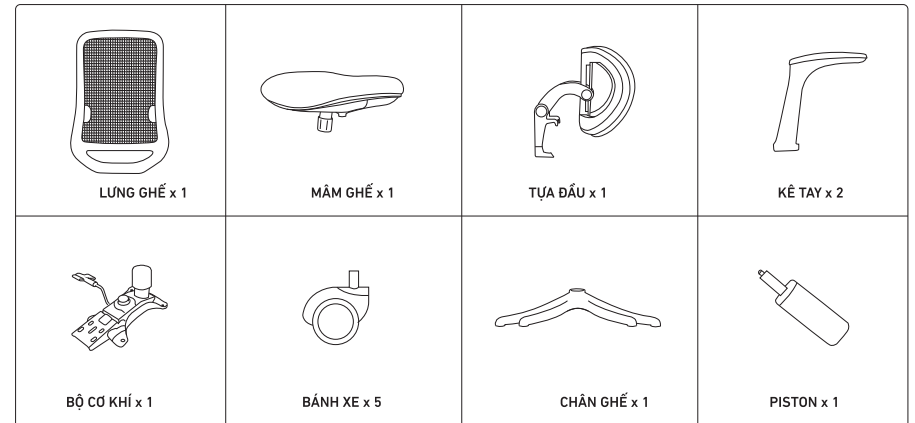

## DANH SÁCH ỐC VÍT

